

DE BOSAL UNI-KLEM M8
LE COLLIER UNIVERSEL BOSAL M8
DIE UNIVERSELLE BOSAL M8 KLEMME
THE BOSAL UNIVERSAL M8 CLAMP

Rond zadel
 A Étrier rond
 Bügelschelle
 Rounded Saddle

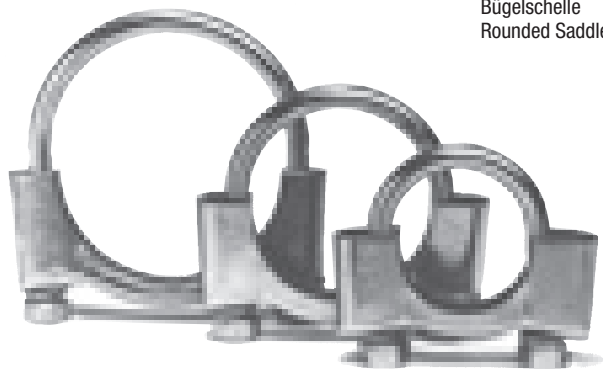

De Bosal Uni-Klem M8

Door zijn specifieke buigvorm en de bewust schuine schouders, zorgt de Bosal Uni-klem voor een gelijkmatige drukverdeling en daardoor voor een perfecte afsluiting

Le collier universel Bosal M8

Grâce aux profil et inclinaison spécifiques, le collier universel Bosal a une répartition de pression uniforme assurant une étanchéité à 100 %.

Die universelle Bosal M8 Klemme

Dank der besonderen Biegeform und der gewollten Schulterneigung erreicht die universelle Bosal Klemme eine gleichmäßige Druckverteilung und demzufolge eine perfekte 100%ige Gasabdichtung.

The Bosal Universal M8 clamp

Thanks to its specific bend-shape and deliberately inclined shoulders, the Bosal universal clamp has an even pressure distribution and therefore a perfect 100% gas tight fit.



Bosal N°	mm Ø	Verpakking / Emballage Verpackung / Packing
250-228	28	1
250-232	32	1
250-236	36	10
250-936	36	100
250-238	38	10
250-938	38	100
250-240	40	10
250-940	40	100
250-242	42	10
250-942	42	100
250-245	45	10
250-945	45	100
250-248	48	10
250-948	48	100
250-250	50	10
250-950	50	100
250-252	52	10
250-952	52	100
250-254	54	10
250-954	54	100
250-258	58	10
250-958	58	100
250-260	60	10
250-960	60	100
250-265	65	10
250-965	65	100

M8 UNIVERSEEL
M8 UNIVERSAL

M8 UNIVERSEL
M8 UNIVERSAL



Vlak zadel
 A Étrier plat
 Flachbügel
 Flat Saddle

Bosal N°	mm Ø	Verpakking / Emballage Verpackung / Packing
250-836	36	10
250-838	38	10
250-840	40	10
250-842	42	10
250-845	45	10
250-848	48	10
250-850	50	10
250-852	52	10
250-854	54	10
250-856	56	10
250-858	58	10
250-860	60	10
250-864	64	10
250-275	75	1
250-283	83	1
250-289	89	1
250-299	100	1



**M10 UNIVERSEEL
M10 UNIVERSAL**

Vlak zadel
 A Étrier plat
 Flachbügel
 Flat Saddle



**M10 UNIVERSEL
M10 UNIVERSAL**

Bosal N°	mm Ø	Verpakking Emballage Verpackung Packing
250-038	38	1
250-040	40	1
250-042	42	1
250-045	45	1
250-048	48	1
250-050	50	1
250-053	53	1
250-055	55	1
250-058	58	1
250-060	60	1
250-070	70	1
250-076	76	1
250-080	80	1
250-085	85	1
250-090	90	1
250-095	95	1
250-100	100	1
250-105	105	1
250-110	110	1
250-115	115	1
250-120	120	1
250-125	125	1
250-128	128	1
250-130	130	1
250-134	134	1
250-141	140	1
250-144	145	1
250-149	150	1
250-156	155	1
250-161	160	1

M8 VOOR/POUR/FÜR/FOR MERCEDES - FIAT - PEUGEOT

Bosal N°	mm Ø	Verpakking Emballage Verpackung Packing
250-438	38,5	1
250-442	42,5	1
250-445	45,5	1
250-448	48,5	1
250-451	51,5	1
250-453	53,5	1
250-454	54,5	1
250-458	58,5	1
250-461	61	1
250-465	65	1



M10 VOOR/POUR/FÜR/FOR FORD

Bosal N°	mm Ø	Verpakking Emballage Verpackung Packing
250-135	35	1
250-138	38	1
250-142	41	10
250-143	43	1
250-145	45	10
250-148	48	10
250-150	50	10
250-151	51	1
250-154	53	10
250-155	55	1
250-158	58	10
250-160	60	1
250-162	62	1
250-164	64	1



M8 VOOR/POUR/FÜR/FOR VOLVO - RENAULT

Bosal N°	mm Ø	Verpakking Emballage Verpackung Packing
250-539	39,5	1
250-542	42	1
250-543	45	1
250-547	48	1
250-551	51	1
250-554	55	1
250-558	58	1
250-561	61	1
250-564	64	1

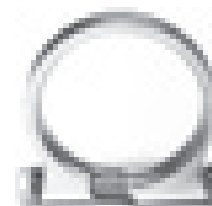

M10 VOOR/POUR/FÜR/FOR AUDI - VOLKSWAGEN

Bosal N°	mm Ø	Verpakking Emballage Verpackung Packing
250-338	38,5	1
250-341	41,5	1
250-342	42,5	1
250-345	45,5	1
250-346	46,7	1
250-348	48,5	1
250-350	49,5	1
250-351	51,5	1
250-352	52,3	1
250-353	53,5	1
250-354	54,5	1
250-356	55,5	1
250-358	58,5	1
250-360	59,5	1
250-362	62,5	1
250-365	64,5	1



M8 VOOR/POUR/FÜR/FOR CITROEN - PEUGEOT - RENAULT

Bosal N°	mm Ø	Verpakking Emballage Verpackung Packing
254-121	47	1
254-371	49	1
254-375	53	1
254-627	58	1
254-920	66	1
254-355*	66	1
254-950	69	1
254-930	72	1
254-940*	79	1

* gelaste moeren/vis soudées/
 geschweißte Schrauben/
 welded bolts

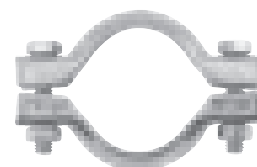

UNIVERSELE PIJPBEUGELS ETRIER DE TUYAU UNIVERSEL UNIVERSAL ROHRBÜGEL UNIVERSAL PIPE HANGERS		
Bosal N°	mm Ø	Verpakking Emballage Verpackung Packing
250-525	25	1
251-933	32	1
251-140	35	1
251-057	38	1
251-626	41	1
251-562	45	1
250-545	45,5	1
251-229	47	1
250-870	48,5	1
250-550	51	1
250-555	53	1

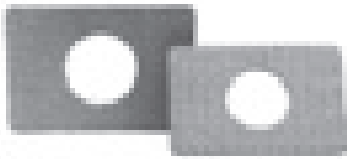

UNIVERSELE OPHANGBEUGELS ETRIER DE SUSPENSION UNIVERSEL UNIVERSAL AUFHÄNGEBÜGEL UNIVERSAL SUSPENSION BRACKETS		
Bosal N°	L	
252-865	210	
252-875	360	

UNIVERSELE PAKKING JOINT D'ÉCHAPPEMENT UNIVERSEL UNIVERSAL DICHTUNGEN UNIVERSAL GASKETS		
Bosal N°	L x B x Ø	
256-032	90 x 60 x Ø 32	
256-035	95 x 65 x Ø 35	
256-038	100 x 70 x Ø 38	
256-042	105 x 75 x Ø 42	

KRAMMEN ATTACHES SPECIALES KLAMMERN CLAMPS		
M8 (*) = M6	mm Ø	Verpakking Emballage Verpackung Packing
Bosal N°		
251-936*	36	1
250-638*	38	1
250-642	42	1
250-645	45	1
250-648	48	1
250-649	50	1
250-654	54	1
250-655	52	1
250-658	58	1
250-661	60	1
250-665	65	1



DISPLAY PRESENTOIR DE COLLIERS AUSSTELLUNGSTAFELN DISPLAY BOARD		
		

UNIVERSELE STRIP LANIERE UNIVERSELLE UNIVERSELLE LASCHEN UNIVERSAL STRIPE			
Bosal N°	L	B	
252-275	320	20	

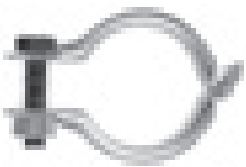

UNIVERSELE MANIFOLDKLEM AUSTIN ETRIER DE SUSPENSION UNIVERSEL UNIVERSAL AUFHÄNGEBÜGEL UNIVERSAL SUSPENSION BRACKETS		
Bosal N°	mm Ø	Verpakking Emballage Verpackung Packing
254-460	43	1
254-470	45	1
254-480	57	1



Bosal N°	Display met inhoud Présentoir de colliers avec contenu Ausstellungstafeln mit Inhalt Display with contents	Verpakking Emballage Verpackung Packing
250-650	M8 Universal 10 st/p 38 - 40 - 42 - 45 - 48 - 50 - 52 - 54 mm	10 st/p
266-087	Lege display met ophanghaken / Présentoir de colliers avec crochets de suspension / Leer Ausstellungstafeln mit Aufhängehaken / Empty display with hanging hooks	
268-092	Losse ophanghaken / Crochets de suspension Separate Aufhängehaken / Spare hanging hooks	25 st/p



**WEERKAPJES
 CHAPEAUX PARE-PLUIE
 LUFTKLAPPEN
 RAIN CAPS**

Bosal N°	mm Ø	
258-151	30 → 52	
258-152	53 → 78	
258-153	79 → 88	
258-154	89 → 113	
258-155	50	 <i>Nieuw Nouveau New New</i>
258-156	65	
258-157	70	
258-158	76	
258-159	89,4	

**OPHANGHAAK
 CROCHETS DE SUSPENSION
 AUFHÄNGEHAKEN
 HANGING HOOK**

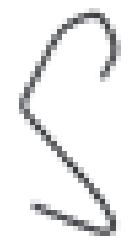
Bosal N°	Verpakking / Emballage Verpackung / Packing	
268-043	100 klein/petit/klein/small	
268-046	25 groot/groot/gross/large	

**SILENTBLOCS
 SILENTBLÖCKE
 INSULATOR BLOCKS**

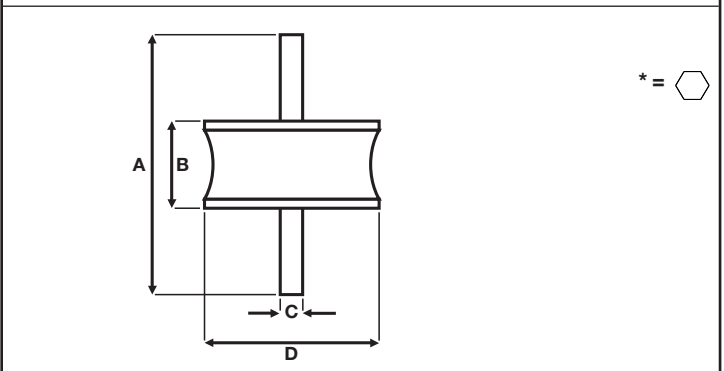

Bosal N°	A	B	C	D Ø
255-015	43	15	m8	30
255-038	48	18	5/16" UNF	32
255-048	45	25	m6	20
255-049	35	15	m6	20
255-330	65	28	m10	42*
255-333	65	28	m8	42*
255-426	48	22	5/16" UNF	40
255-453	62	30	m6	20
255-458	60	20	5/16" UNF	32
255-473	70	30	m8	30
255-517	70	30	m8	40
255-627	51	25	m6	22
255-736	68	34	3/8" UNF	58

**UITLAATCEMENT
 PÂTE D'ÉTANCHÉITÉ
 AUSPUFFZEMENT
 MUFFLER CEMENT**



Bosal N°	Verpakking / Emballage Verpackung / Packing
258-501	2 x 570 gr.
258-502	5 x 190 gr.
258-503	10 x 60 gr. N/F
258-504	10 x 60 gr. D/E
258-011	1 x 250 gr.
258-021	1 x 500 gr.
258-020	1 x 330 gr.



**MAGNETISCH ETIKET "BOSAL" / ETIQUETTE MAGNÉTIQUE "BOSAL"
 MAGNETETIKETTEN "BOSAL" / MAGNETIC LABEL "BOSAL"**

Bosal N°	Verpakking / Emballage Verpackung / Packing	Afmeting / Dimension Abmessung / Size in / en (mm)
268-048	100	95 x 15
268-047	100	95 x 30

**MAGNETISCH ETIKET NEUTRAAL / ETIQUETTE MAGNÉTIQUE NEUTRE
 MAGNETETIKETTEN NEUTRAL / MAGNETIC LABEL NEUTRAL**

Bosal N°	Verpakking / Emballage Verpackung / Packing	Afmeting / Dimension Abmessung / Size in / en (mm)
268-049	100	95 x 15
268-044	100	95 x 20
268-037	100	95 x 25
268-045	100	95 x 30

SLUITRINGEN/VEERRINGEN RONDELLES/RONDELLES DE FRICTION RINGE/FEDERRINGE WASHERS/SPRING WASHERS	Bosal N°	Ø	DIN	Model
	258-104	m4	DIN 127	A
	258-106	m6	DIN 127	A
	258-107	m7	DIN 127	A
	258-108	m8	DIN 127	A
	258-110	m10	DIN 127	A
	258-112	m12	DIN 127	A
	258-113	m6 x Ø 18 x 1,4		B
	258-114	m14	DIN 127	A
	258-115	m6 x Ø 12 x 1,5	DIN 125	B
	258-116	m6 x Ø 24 x 1,5		B
	258-117	m8 x Ø 17 x 1,5	DIN 125	B
	258-118	Ø 8	Renault	D
	258-119	m7 x Ø 14 x 1,5	DIN 125	B
	258-120	Ø 10	Opel	D
	258-121	m8 x Ø 21 x 4		B
	258-125	Ø 40 x Ø 8 x 3		C
	258-126	Ø 32 x Ø 16 x 1		C
	258-130	m8 x Ø 30 x 1		B
	258-131	m10 x Ø 30 x 2,5		B
	258-133	m10 x Ø 21 x 2	DIN 125	B
	258-135	m12 x Ø 24 x 2,3	DIN 125	B
	258-784	Ø 21 x Ø 10 x 3		C

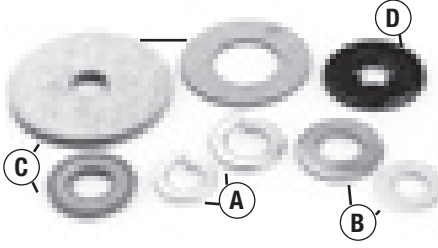

Verpakking/Emballage 10
Verpackung/Packing 10

BOUTEN VIS SCHRAUBEN BOLTS	Verpakking 10 Emballage 10 Verpackung 10 Packing 10 * = 1
	

Bosal N°	Ø x L
258-450	m4 x 50
258-510	m5 x 10
258-610	m6 x 10
258-616	m6 x 16
258-620	m6 x 20
258-625	m6 x 25
258-630	m6 x 30
258-640	m6 x 40
258-645	m6 x 45
258-650	m6 x 50
258-660	m6 x 60
258-675	m6 x 75
258-680	m6 x 80
258-720	m7 x 20
258-730	m7 x 30
258-740	m7 x 40
258-760*	m7 x 60
258-816	m8 x 16
258-820	m8 x 20
258-825	m8 x 25
258-830	m8 x 30
258-835	m8 x 35
258-840	m8 x 40
258-845	m8 x 45
258-850	m8 x 50
258-855	m8 x 55
258-860	m8 x 60
258-865	m8 x 65
258-870	m8 x 70
258-875	m8 x 75
258-880*	m8 x 80
258-888*	m8 x 90
258-889*	m8 x 100
258-923*	m8 x 130
258-886*	m10 x 20
258-884*	m10 x 25
258-893*	m10 x 1,25 x 25
258-890*	m10 x 30
258-887*	m10 x 1,25 x 30
258-885*	m10 x 35
258-907*	m10 x 1,25 x 35
258-891*	m10 x 40
258-906*	m10 x 1,25 x 40
258-892*	m10 x 50
258-883*	m10 x 55
258-908*	m10 x 1,25 x 60
258-896*	m10 x 65
258-897*	m10 x 70
258-902*	m10 x 1,25 x 70
258-899*	m10 x 80
258-909*	m10 x 85
258-905*	5/16 x 3/4" UNF
258-910*	5/16 x 1" UNF
258-915*	5/16 x 1 1/2" UNF
258-920*	5/16 x 2" UNF
258-924*	m12 x 1,25 x 35

VEREN RESSORTS FEDERN SPRINGS	Verpakking/Emballage 10 Verpackung/Packing 10	Bosal N°	Toepassing/Application Anwendung/Application	L	Model A/B
		251-001	Suzuki	44	A
		251-003	Mitsubishi	54	A
		251-004	Peugeot	28	A
		251-007	BMW/Mercedes	37	A
		251-203	Honda/Austin/Rover/ Suzuki	38	A
		251-298	Mazda	28	A
		251-443	Citroën	17,5	A
		251-458	Citroën/Peugeot/Seat/ Subaru/Renault	26	A
		251-515	British Leyland	182	B
		251-530	Austin/Rover/Triumph	120	B
		251-534		96	B
		251-669	Ford Escort/TalbotMitsubishi	77	B
		251-693		56	A
		251-807	Ford	28	A
		251-860	Opel	38	A
		251-863	Opel	33	A
		251-902	Fiat/Lancia	30	A
		251-903	Mercedes/Fiat/Seat	38	A
		251-929	Audi/Volkswagen	46	A
		251-930	Audi/Volkswagen	35	A
		251-932	Audi/Volkswagen	34	A
		251-934	Renault	48	A
		251-935	Subaru	28	A
		251-971	Renault	51	A

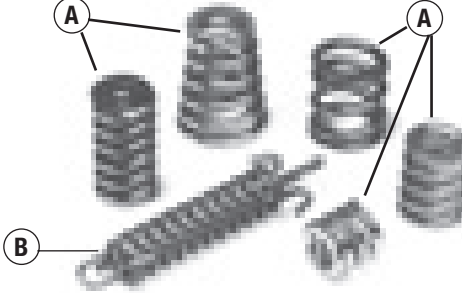

TAPEINDEN GOUJONS STEBBOLZEN STUD BOLTS	Verpakking 10 Emballage 10 Verpackung 10 Packing 10 * = 1	Bosal N°	Ø x L	Toepassing/Applic. Anwendung/Applic.
		258-013*	m10 x 1,25 x 47	Suzuki
		258-946*	m8 x 41	Honda
		258-948	m8 x 35	Audi/Fiat/Opel/ Renault/VW
		258-949	m8 x 43	Alfa Romeo/ Talbot/Renault Datsun/Nissan
		258-950	m8 x 45	Honda
		258-947*	m10x1,25x43	Honda
		258-951	m10x1,25x37	Toyota
		258-952	m10 x 38	Mazda
		258-953	m10 x 40	Volvo
		258-954	m10 x 47	Ford Taunus
		258-955	m10 x 55	Ford
		258-927	m12 x 1,25x50	Hyundai
		258-956*	5/16" UNFx42	British Leyland
		258-957*	5/16" UNCX47	Ford (GB)
		258-958*	3/8" UNF x 47	Vauxhall
		258-959*	3/8" UNC x 41	Volvo
		258-987	m10x1,25x94	Hyundai



SPECIALE BOUTEN VIS SPECIALES SPEZIAL SCHRAUBEN SPECIAL BOLTS	Verpakking 1 Emballage 1 Verpackung 1 Packing 1	Bosal N°	Ø x L	Toepassing/Applic. Anwendung/Applic.
		258-015	m6 x 58	Peugeot 205
		258-771	m6 x 53	Citroën/Peugeot
		258-780	m7 x 80	Citroën/Peugeot
		258-781	m6 x 46	Citroën/Peugeot
		258-785	m6 x 42	Citroën/Peugeot
		258-023	m6/m8 x 77	Citroën/Peugeot
		258-786	m6 x 77	Peugeot
		258-788	m8 x 1,25 x 108	Ford
		258-789	m10 x 70	Ford L40
		258-790	m10 x 70	Ford L50
		258-791	m6 x 57	Citroën/Peugeot
		258-793	m7 x 67	Citroën/Peugeot
		258-794	m8 x 63	Opel Vectra
		258-986	m10 x 1,25 x 75	Mazda
		258-726	m8 x 107	Renault
		258-894	m10 x 65	Hyundai Pony
		258-895	m10 x 73	Opel Kadett D-E
		258-904	m10 x 57	Corsa A
		258-942	m10x1,25x52	Opel Corsa 1000 S
		258-943	m10x1,25x65	Suzuki
		258-944	m8 x 60	Suzuki Austin/Honda



AFSTANDSBUSJES ENTRETOISES Distanzbüchsen SPACER TUBES	Verpakking 1 Emballage 1 Verpackung 1 Packing 1	Bosal N°	D x d x l
		258-930	Ø 12 x Ø 8,5 x 48
		258-960	Ø 12 x Ø 8,5 x 25
		258-962	Ø 14 x Ø 10 x 8
		258-964	Ø 12 x Ø 8,5 x 37
		258-965	Ø 12 x Ø 8,5 x 40
		258-966	Ø 12 x Ø 8,5 x 22
		258-931	Ø 12 x Ø 8,5 x 32
		258-932	Ø 12 x Ø 8,5 x 43
		258-933	Ø 12 x Ø 8,5 x 58
		258-935	Ø 18 x Ø 8,5 x 10
		258-936	Ø 11 x Ø 8,5 x 38
		258-934	Ø 11 x Ø 8,5 x 72
		258-937	Ø 11 x Ø 8,5 x 39
		258-967	Ø 10 x Ø 4,2 x 32
		258-938	Ø 10 x Ø 6,5 x 47
		258-939	Ø 15 x Ø 10,5 x 40
		258-940	Ø 15 x Ø 10,5 x 50





**MONTAGETOEBEHOREN / UNIVERSELE DEMPERLIJN
ACCESSOIRES DE MONTAGE / SILENCIEUX UNIVERSELS
MONTAGEZUBEHÖR / UNIVERSALSCHALLDÄMPFER
MOUNTING ACCESSORIES / UNIVERSAL SILENCER LINE**



MOEREN ECROUS MUTTERN NUTS			
Bosal N°	mm Ø	DIN/ANSI Cu: verkoperd/cuivré verkuftert/copper plated	Toepassing / Application Anwendung / Application
258-005	m4	DIN 934	
258-006	m6	DIN 934	Peugeot
258-026	m6	DIN 980 V/8 Cu	Peugeot
258-036	m6	DIN 267 Cu	Fiat
258-007	m7	DIN 934 V/8	Peugeot Citroen
258-008	m8	DIN 934	Fiat Peugeot
258-009	m8	DIN 936/H4	Renault
258-028	m8	DIN 980 V/9 Cu	Alfa Romeo
258-038	m8	DIN 267 Cu	Fiat Nissan BMW Honda
258-053	m8	MESSING	Lada
258-010	m10	DIN 934	Peugeot
258-040	m10	DIN 267 Cu	Volvo Austin Nissan
258-047	m10 x 1,25	DIN 267 Cu	Toyota / Daihatsu Mazda
258-052	m10 x 1,25	MESSING	Daihatsu
258-056	m10 x 1,25	DIN 980 V/8 Cu	Nissan Hyundai
258-030	m10 x 1,5	DIN 980 V/8 Cu	Ford
258-050	m10 x 1,5 SW 14	DIN 980 V/8 Cu	Mazda
258-012	m12 x 1,75	DIN 934	Hyundai Volvo
258-055*	m12 x 1,5	DIN 934	Mazda
258-060	m12 x 1,25	DIN 934/8	Mitsubishi
258-014	m14	DIN 934	Nissan
258-016	5/16 UNF	ANSI B 18-2-2/8	Austin
258-017	5/16 UNC	ANSI B 18-2-2/8	
258-018	3/8 UNF	ANSI B 18-2-2/8	Austin
258-051	3/8 UNC	ANSI B 18-2-2/8	

Verpakking 10
Emballage 10
Verpackung 10
Packing 10
* = 1

VERKOPERDE ZELFBORGENDE MOEREN ECROUS CUIVRE AUTOSERRANTS VERKOPFERTE SICHERUNGSMUTTERN COPPER PLATED SELFLOCKING NUTS		
Bosal N°	mm Ø	Verpakking/Emballage Verpackung/Packing
258-326	m6	50 x 258-026
258-328	m8	50 x 258-028
258-330	m10	50 x 258-030
258-350	m10/SW14	50 x 258-050
258-356	m10 x 1,25	50 x 258-056

VERKOPERDE FLENSMOEREN ECROUS A EMBASE VERKOPFERTE FLANSCHMUTTERN COPPER PLATED FLANGE NUTS		
Bosal N°	mm Ø	Verpakking/Emballage Verpackung/Packing
258-336	m6	50 x 258-036
258-338	m8	50 x 258-038
258-340	m10	50 x 258-040
258-347	m10 x 1,25	50 x 258-047

VERZINKTE MESSINGMOEREN ECROUS ZINGUE/LAITON VERZINKTE/MESSINGMUTTERN ZINCPLATED/BRASSED NUTS		
Bosal N°	mm Ø	Verpakking/Emballage Verpackung/Packing
258-306	m6	50 x 258-006
258-308	m8	50 x 258-008
258-310	m10	50 x 258-010
258-352	m10 x 1,25 messing	50 x 258-052
258-353	m8 messing	50 x 258-053

**ASSORTIMENTSDOZEN
BOITES D'ASSORTIMENT
SORTIMENTKASTEN KOMPLETT
ASSORTMENT BOXES**

Assortimentsdoos Boîtes d'assortiment Sortimentkasten Assortment boxes	Vakken (leeg) Compartiments (vide) Fächer (leer) Compartments (empty)
258-988	12
258-989	8

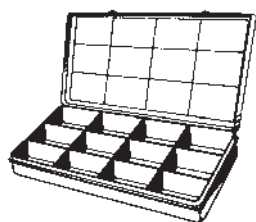

258-990 Tapeinden/Moeren Goujons/ECROUS Bolzen/Muttern Bolts/Nuts	258-991 Afstandsbusjes Entretoises Distanzbüschchen Spacer tubes	258-992 Speciale bouten Boulons spéciaux Spezialschrauben Special bolts	258-994 Uitlaatveren Ressorts Federn Springs	258-995 Sluitringen/Veerringen Rondelles/Rondelles de friction Ringe/Federringe Washers/Springwashers	258-996 Bouten Vis Bolzen Bolts M4/M5/M6/M7	258-997 Bouten Vis Bolzen Bolts M8/M10	258-998 Moeren ECROUS Muttern Nuts	258-999 Tapeinden Goujons Stehbolzen Stud Bolts									
258-013	20	258-930	8	258-015	2	251-298	4	258-106	30	258-450	10	258-816	10	258-007	20	258-948	10
258-038	40	258-931	8	258-780	6	251-458	4	258-107	30	258-510	10	258-820	10	258-016	20	258-949	10
258-047	25	258-932	8	258-781	6	251-693	4	258-108	30	258-616	10	258-825	10	258-026	20	258-950	10
258-946	20	258-933	8	258-787	4	251-860	4	258-110	30	258-620	10	258-830	10	258-028	20	258-951	10
258-947	20	258-935	8	258-791	4	251-903	4	258-115	30	258-625	10	258-835	10	258-036	20	258-952	10
258-950	20	258-936	8	258-895	6	251-807	4	258-116	30	258-630	10	258-840	10	258-038	20	258-953	10
258-951	10	258-960	8	258-904	6	251-929	4	258-117	30	258-640	10	258-845	10	258-040	20	258-954	10
258-952	10	258-962	8	258-944	6	251-971	4	258-118	30	258-645	10	258-850	10	258-047	20	258-955	10
		258-964	8					258-120	30	258-650	10	258-890	10	258-050	20	258-956	10
		258-965	8					258-130	30	258-660	10	258-891	10	258-052	20	258-957	10
		258-966	8					258-131	30	258-730	10	258-892	5	258-053	20	258-958	10
		258-967	8					258-133	30	258-740	10			258-056	20	258-959	10

RONDE STALEN BUIZEN VOOR UITLAATSYSTEMEN TUBES RONDS POUR SYSTEMES D'ÉCHAPPEMENT RUNDE ROHRE FÜR AUSPUFFANLANGEN ROUND TUBES FOR EXHAUST SYSTEMS			
Bosal N°	D (mm)	L (m)	Mat.dikte Epaisseur Mat.-Stärke Mat. thickness
261-132	32	3,00	1,50 mm
261-135	35	3,00	1,50 mm
261-138	38	3,00	1,50 mm
261-142	42	3,00	1,50 mm
261-145	45	3,00	1,50 mm
261-238	38	3,00	2,00 mm
261-242	42	3,00	2,00 mm
261-245	45	3,00	2,00 mm
261-248	48	3,00	2,00 mm
261-250	50	3,00	2,00 mm
261-254	54	3,00	2,00 mm
261-257	57	3,00	2,00 mm
261-265	65	3,00	2,00 mm
261-276	76,2	3,00	2,00 mm
261-825	25	1,95	1,50 mm
261-830	30	1,95	1,50 mm
261-832	32	1,95	1,50 mm
261-835	35	1,95	1,50 mm
261-838	38	1,95	1,50 mm
261-841	42	1,95	1,50 mm
261-845	45	1,95	1,50 mm
261-848	48	1,95	1,50 mm
261-850	50	1,95	1,50 mm
261-854	54	1,95	1,50 mm
261-857	57	1,95	1,50 mm
261-860	60	1,95	2,00 mm
261-863	65	1,95	2,00 mm
261-870	70	1,95	2,00 mm
261-875	76	1,95	2,00 mm
261-880	80	1,95	2,00 mm
261-883	83	1,95	2,00 mm
261-889	90	1,95	2,00 mm
261-900	102	1,95	2,00 mm
261-910	110	1,95	2,00 mm
261-920	114	1,95	2,00 mm
261-950	127	1,95	2,00 mm

STALEN BUIZEN
TUBES EN ACIER
PRÄZISIONSSTAHLROHRE
STEEL TUBES

LASBOCHTEN 90° COUDES 90° 90° GEBOGENE ROHRE WELDING BENDS 90°		
Bosal N°	D (mm)	Mat.dikte Epaisseur Mat.-Stärke Mat. thickness
263-625*	25	1,50 mm
263-628*	28	1,50 mm
263-632*	32	1,50 mm
263-635*	35	1,50 mm
263-638*	38	1,50 mm
263-641*	42	1,50 mm
263-645*	45	1,50 mm
263-648*	48	1,50 mm
263-650*	50	2,00 mm
263-653*	54	2,00 mm
263-657*	57	2,00 mm
263-660*	60	2,00 mm
263-665*	65	2,00 mm
263-670*	70	2,00 mm
263-675*	76	2,00 mm
263-680	80	2,00 mm
263-683	83	2,00 mm
263-689*	90	2,00 mm
263-700*	102	2,00 mm
263-720*	114	2,00 mm
263-750*	127	2,00 mm

* Gealuminiseerd * Aluminisé
* Aluminisiert * Aluminised



KOPPELSTUKKEN TUBULURES DE RACCORDEMENT ROHRVERBINDER PIPE CONNECTORS	
Bosal N°	d (mm)
265-928*	28
265-932*	32
265-935*	35
265-938*	38
265-941*	42
265-945*	45
265-948*	48
265-950*	50
265-953*	54
265-957*	57
265-960*	60
265-963*	65
265-970*	70
265-975*	76
265-980	80
265-983	83
265-989*	89
265-999*	102
265-720*	114
265-750*	127

* Gealuminiseerd * Aluminisé
* Aluminisiert * Aluminised

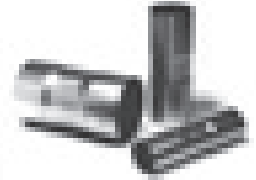

VERLOOPBUSSEN RACCORDS DE REDUCTION REDUZIERSTÜCKE REDUCING BUSHES			
Bosal N°	d (mm)	D (mm)	L (mm)
264-728	28	25	80
264-732*	32	28	80
264-735*	35	32	80
264-738*	38	35	80
264-741*	41	38	80
264-745*	45	42	80
264-748*	48	45	80
264-750*	50	48	80
264-753*	54	50	80
264-775*	76	70	80

* Gealuminiseerd * Aluminisé
* Aluminisiert * Aluminised

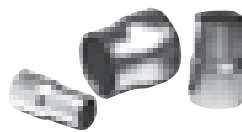

GEALUMINISEERDE BUIS TUBE ALUMINIE ALUMINISIERTE ROHRE ALUMINISED TUBE			
Bosal N°	D (mm)	L (m)	Mat.dikte Epaisseur Mat.-Stärke Material thickness
262-142	42	3,00	1,50 mm
262-145	45	3,00	1,50 mm
262-238	38	3,00	2,00 mm
262-242	42	3,00	2,00 mm
262-245	45	3,00	2,00 mm
262-248	48	3,00	2,00 mm
262-250	50	3,00	2,00 mm
262-254	54	3,00	2,00 mm
262-257	57	3,00	2,00 mm
262-263	65	3,00	2,00 mm

GEALUMINISEERDE REPARATIEPIJPEN TUBES D'EXTENSION ALUMINIES ALUMINISIERTE ROHRVERLÄNGERUNGEN ALUMINISED PIPE EXTENSIONS			
Bosal N°	d (mm)	D (mm)	L (mm)
264-428	28	28	400
264-432	32	32	400
264-435	35	35	400
264-438	38	38	400
264-441	42	42	400
264-445	45	45	400
264-448	48	48	400
264-450	50	50	400



D = BUITENDIAMETER D = DIMENSION EXTERIEURE D = AUSSENDURCHMESSER D = OUTSIDE DIAMETER		L = LENGTE L = LONGUEUR L = LÄNGE L = LENGHT	
d = BINNENDIAMETER d = DIMENSION INTERIEURE d = INNENDURCHMESSER d = INSIDE DIAMETER			



MONTAGETOEBEHOREN / UNIVERSELE DEMPERLIJN
 ACCESSOIRES DE MONTAGE / SILENCIEUX UNIVERSELS
 MONTAGEZUBEHÖR / UNIVERSALSCHALLDÄMPFER
 MOUNTING ACCESSORIES / UNIVERSAL SILENCER LINE

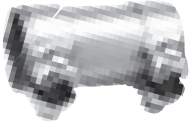
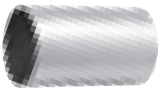
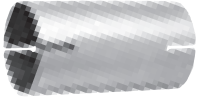

KOPPELSTUKKEN TUBULURES DE RACCORDEMENT ROHRVERBINDER PIPE CONNECTORS	Bosal N°	Type	d (mm)	L (mm)	OE-n°	Make
TYPE A 	265-135	A	38	95	820253141	VAG
	265-131	C	42	145	856 184	Opel
TYPE B 	265-810	A	40	80	24430557	Vauxhall
	265-125	A	43	125	77.03.083.455	Citroen/Peugeot
	265-895	A	45	80	191.253.141E	VAG
	265-619	A	45	120	77 03 083 443	Citroen/Peugeot
	265-813	C	45	145	1736.05	Citroen/Peugeot
TYPE C 	265-169	B	42	160	92 02 051	Opel/Vauxhall
					856 179	Opel
					904 86261	Vauxhall
	265-129	A	46	95	1H0.253.141B	VAG
	265-833	A	50	80	77 03 083 396	Citroen/Peugeot
	265-687	A	50.5	95	893.253.139 / 1736.13 / 18 10 1 439 722	VAG/Citroen/Peugeot
	265-459	A	50.5	125	191.253.141M	VAG/BMW
	265-505	A	53	95	8N0.253.145	VAG
	265-621	A	55	120	1736.04	Citroen/Peugeot
	265-827	A	56	95	893.253.139A	VAG
	265-119	A	56	125	357.253.141A	VAG
	265-127	A	60.5	80	18 20 1 742 445	BMW
	265-829	A	61	95	893.253.139C	VAG
	265-955	A	61	125	893.253.139B	VAG
	265-897	B	42.5	80	18 11 1 175 884	BMW
	265-942	C	52	120		Ford
	265-891	C	42	120		BMW
	265-909	C	45	120	18 12 1 177 558	BMW
	265-251	C	49	120	18 11 1 177 000	BMW
	265-913	C	50	120	18 11 1 723 679	BMW
	265-893	C	55	120	18 11 1 177 001	BMW
				18 12 1 175 754	BMW	
				77 03 083 398	Renault	
265-617	C	60	100	1736.06	Citroen/Peugeot	
265-123	C	60	120		BMW	
265-129	A	46	88	18 12 1 178 184	BMW	
				1736.10	Citroen/Peugeot	

FLEXIBELE PIJVERBINDINGSSTUKKEN, VOOR PERSONENWAGENS
 TUYAUX FLEXIBLES POUR VOITURES
 FLEXIBLE ROHRVERBINDER FÜR PKW
 FLEXIBLE PIPE CONNECTORS SPECIALLY FOR PASSENGER CARS

INNERBRAID
 Met metaalgevlochten binnenlaag
 Avec gaine intérieure tressée
 Mit Metallgeflechtes Inner Liner
 With innerbraid inner liner



INTERLOCK
 Met ineengehaakte binnenlaag
 Avec gaine de verrouillage intérieure
 Mit Interlock Inner Liner
 With interlock inner liner



Bosal N°	Type	d (mm)	L flex (mm)	L total (mm)	Bosal N°	Type	d (mm)	L flex (mm)	L total (mm)
265-609	A	38.0	158	272	265-205	B	25.5	155	155
265-611	A	42.0	158	272	265-709	A	38.0	158	272
265-613	A	42.0	269	383	265-711	A	42.0	158	272
265-677	B	45.0	250	250	265-713	A	42.0	269	383
265-561	B	45.0	95	95	265-307	B	45.0	153	153
265-715	A	45.0	158	272	265-309	B	45.0	200	200
265-631	A	48.0	158	272	265-311	B	45.0	230	230
265-517	A	50.0	158	272	265-577	B	45.0	250	250
265-519	A	50.0	208	322	265-313	B	45.0	260	260
265-521	A	50.0	269	383	265-701	A	45.0	158	272
265-679	B	50.5	200	200	265-703	A	45.0	208	322
265-681	B	50.5	250	250	265-705	A	45.0	269	383
265-567	B	51.0	100	100	265-305	B	45.5	102	102
265-573	B	51.0	190	190	265-565	B	46.0	190	190
265-623	A	52.0	126	240	265-731	A	48.0	158	272
265-625	A	52.0	208	322	725-387	A	48.0	206	408
265-627	A	54.0	158	272	265-319	A	49.0	166	200
265-571	B	55.5	190	190	265-315	B	50.0	95	95
265-585	B	55.7	105	105	265-321	B	50.0	230	230
265-629	A	60.0	158	272	265-717	A	50.0	158	272
265-587	B	60.0	120	120	265-325	B	50.0	282	282
					265-719	A	50.0	208	322
					265-721	A	50.0	269	383
					265-579	B	50.5	200	200
					265-581	B	50.5	250	250
					265-317	B	51.0	150	150
					265-323	B	51.0	252	252
					265-707	A	51.5	156	270
					265-723	A	52.0	126	240
					265-725	A	52.0	208	322
					265-331	B	54.0	200	200
					265-727	A	54.0	158	272
					739-137	A	54.0	200	345
					265-329	B	55.0	150	150
					265-333	B	55.0	220	220
					265-335	B	55.0	250	250
					265-337	B	55.0	280	280
					265-327	B	56.5	101	101
					265-729	A	60.0	158	272
					265-339	B	63.0	203	203
					265-341	B	63.0	252	252

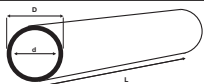

L = LENGTE
 L = LONGUEUR
 L = LÄNGE
 L = LENGHT

D = BUITENDIAMETER
 D = DIMENSION EXTERIEURE
 D = AUSSENDURCHMESSER
 D = OUTSIDE DIAMETER

d = BINNENDIAMETER
 d = DIMENSION INTERIEURE
 d = INNENDURCHMESSER
 d = INSIDE DIAMETER

GEGALVANISEERDE FLEXIBELE PIJPEN
TUYAUX FLEXIBLES GALVANISES
GELVANISIERTE FLEXIBLE ROHRE
GALVANISED FLEXIBLE TUBES



INDUSTRIEKWALITEIT
QUALITE INDUSTRIELLE
INDUSTRIEQUALITÄT
INDUSTRIAL QUALITY

KWALITEIT VOOR UITLAATSYSTEMEN
 (met koperdichting- dubbel ineengehaakt)
QUALITE POUR SYSTEMES D'ECHAPPEMENT
 (joint de cuivre - double agrafage)
SPEZIALQUALITÄT FÜR ABGASANLAGEN
 (Kupferummantelung doppelt gesichert)
SPECIAL QUALITY FOR EXHAUST SYSTEMS
 (copper packed interlock)

Bosal N°	d (mm)	L (m)	Bosal N°	d (mm)	L (m)
260-920	19	6	260-025	25	2
260-925	25	6	260-028	28	2
260-928	28	6	260-032	32	2
260-932	32	6	260-035	35	2
260-935	35	6	260-038	38	2
260-938	38	6	260-041	41	2
260-941	41	6	260-045	45	2
260-945	45	6	260-048	48	2
260-948	48	6	260-050	50	2
260-950	50	6	260-053	53	2
260-953	53	6	260-057	57	2
260-957	57	6	260-060	60	2
260-960	60	6	260-065	65	2
260-965	65	6	260-070	70	2
260-970	70	6	260-075	75	2
260-975	75	6	260-080	79	2
260-980	80	6	260-085	83	2
260-985	85	6	260-090	89	2
260-990	90	6	260-100	102	2
260-999	100	6	260-110	114	2
			260-125	127	2

FLEXIBELE PIJPVERBINDINGSSTUKKEN,
SPECIAAL VOOR VRACHTWAGENS
TUYAUX FLEXIBLES POUR CAMIONS
FLEXIBLE ROHRVERBINDER FÜR LKW
FLEXIBLE PIPE CONNECTORS SPECIALLY FOR TRUCKS



Bosal N°	d (mm)	L (cm)
265-560	60	80 cm
265-610	110	80 cm

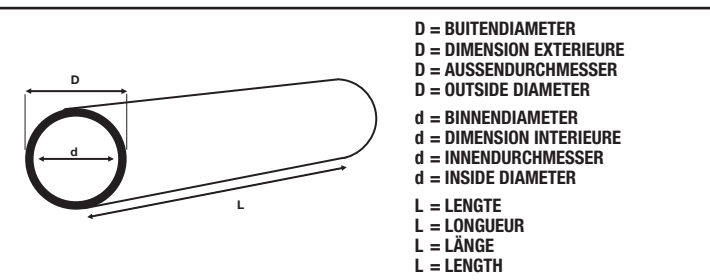

UNIVERSELE DEMPERS
SILENCIEUX UNIVERSELS
UNIVERSALSCHALLDÄMPFER
UNIVERSAL SILENCER LINE

Afmetingen in mm
 Dimensions en mm
 Abmessungen in mm
 Dimensions in mm

<p>248-004</p>	<p>248-062</p>
<p>248-169</p>	<p>248-161</p>
<p>248-009</p>	<p>248-160</p>
<p>248-156</p>	<p>248-158</p>
<p>248-155</p>	<p>248-159</p>
<p>248-153</p>	<p>248-184</p>
<p>248-010</p>	<p>248-012</p>
<p>248-016</p>	<p>248-014</p>
<p>248-163</p>	<p>248-011</p>
<p>248-013</p>	<p>248-165</p>
<p>248-002</p>	<p>248-185</p>

Zonder EU homologatie / Sans homologation EU / Ohne EU Bestätigung / Without EU homologation



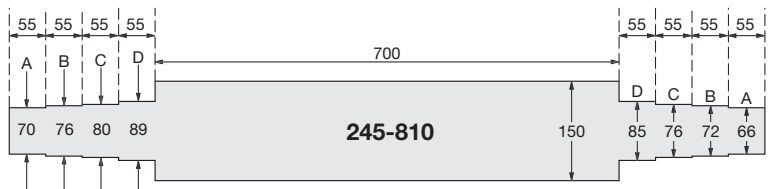



UNIVERSELE VRACHTWAGEN DEMPERS
SILENCIEUX UNIVERSEL CAMION
UNIVERSAL LKW SCHALLDÄMPFER
UNIVERSAL TRUCK SILENCER



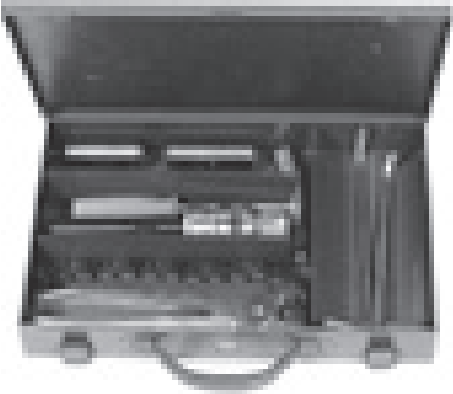
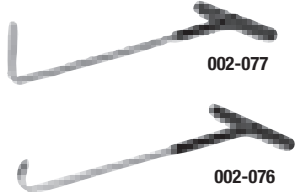
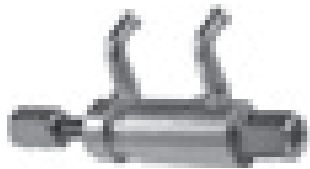

**GEREEDSCHAPPEN /UITRUSTING VOOR WERKPLAATS
OUTILLAGE / EQUIPEMENT DE VOTRE ATELIER
WERKZEUGE / AUSRÜSTUNG FÜR DIE WERKSTATT
TOOLS / EQUIPMENT FOR WORK PLACE**

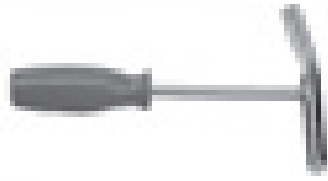

<p>GEREEDSCHAPPEN OUTILLAGE WERKZEUGE TOOLS</p> 	<p>002-076 / 002-077 Uitlaatrubbretrekker Poignée de traction Montagewerkzeug für Gummiaufhängung Rubber mounting extractor</p> 	<p>002-082 Gereedschap voor dé- en montage van VW-systemen Outil pour le montage et démontage des systèmes VW Demontiergerät für VW Systeme Tool for removing and fitting the VW systems</p> 
	<p>002-080(8mm) 002-081 (10 mm) Tapeind-rotor / Extracteur de goujons Stehbolzenauszieher / Stud rotor</p> 	<p>002-031 Afsnijgereedschap voor pijpen van 18 tot 75 mm doorsnede Outil pour couper des tuyaux de 18 jusqu'à 75 mm de diamètre Absägeapparat für Rohre von 18 bis 75 mm Durchmesser Cutter for exhaust and tail pipes from 18 to 75 mm diameter</p> 
	<p>002-078 Komplete gereedschapskist om uitlaatsystemen te monteren: Nécessaire complet d'outils pour le montage des systèmes d'échappement: Kompletter Werkzeugkasten für die Montage von Auspuffanlagen: Complete kit of tools to mount exhaust systems: 002-031 / 002-070 / 002-074 / 002-076 / 002-077 / 002-080 / 002-081</p>	<p>002-083 Pijphersteller / Cône redresseur Rohrprofilwerkzeug / Pipeshaper</p> 
	<p>002-074 Beitel met handvat Ciseau avec poignée Meißel mit Griff Chisel with handle</p> 	<p>002-070 35 – 50 mm 002-071 45 – 65 mm Uitzetgereedschap voor pijpen. Outil pour expandre des tuyaux Ausdehnapparat für Rohre Expander for pipes</p> 

**ASSTEUN
CHANDELLE
UNTERSTELLBOCK
TRESTLE**

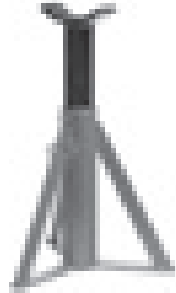

Bosal N°	Capaciteit/Capacité Kapazität/Capacity	Hoogte / Hauteur / Höhe / Height	
		Min.	Max.
009-002	2 T	285 mm	385 mm

**SCHAARKRIK
CRIC LOSANGE
SCHERENWAGENHEBER
SCISSOR JACK**



Bosal N°	Capaciteit/Capacité Kapazität/Capacity
017-850	1.0 T

**GARAGE ROLMAT
CHARIOT DE VISITE
ROLLBRETT
GARAGE CREEPER**

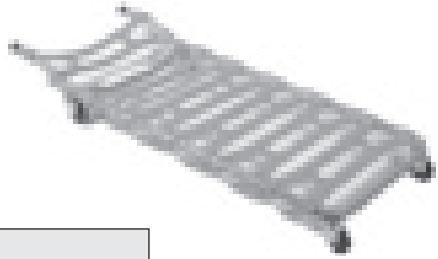

Bosal N°	
096-096	Rolmat / Chariot de visite
080-001	Rollbrett / Garage creeper Zwenkwiel / Roulette Ersatz-Rollen / Caster

**WERKZIT
CHARIOT DE TRANSPORT
ARBEITSSITZ
WORK-SEAT**



Bosal N°
099-098

5

VERCHROOMDE SIERSTUKKEN ENJOLIVEURS CHROMES VERCHROMTE ROHRBLENDEN CHROME PIPES

bosal

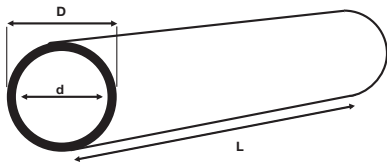

L = LENGTE
L = LONGUEUR
L = LÄNGE
L = LENGTH

T = TOEPASSING
T = APPLICATION
T = PASSEND FÜR
T = APPLICATION

D = BUITENDIAMETER
D = DIMENSION EXTERIEURE
D = AUSSENDURCHMESSER
D = OUTSIDE DIAMETER

d = BINNENDIAMETER
d = DIMENSION INTERIEURE
d = INNENDURCHMESSER
d = INSIDE DIAMETER



Bosal N°	d	L	T
267-011	Ø 41-44 mm	70 mm	Universal

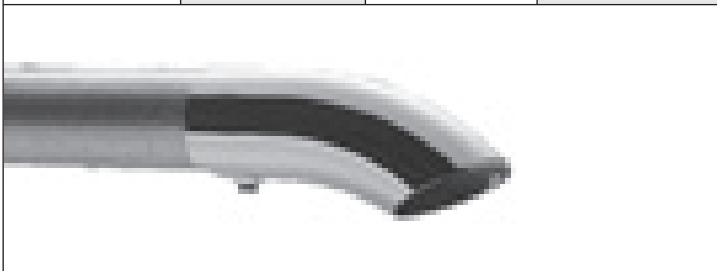

Bosal N°	d	L	T
267-015	Ø 39-43 mm	140 mm	Universal
267-017	Ø 44-47 mm	140 mm	Universal
267-018	Ø 48-52 mm	140 mm	Universal
267-019	47/56 oval	140 mm	Audi 100 1983

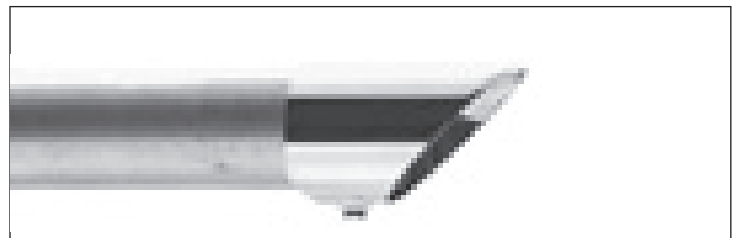

Bosal N°	d	L	T
267-012	Ø 49	80 mm	Universal

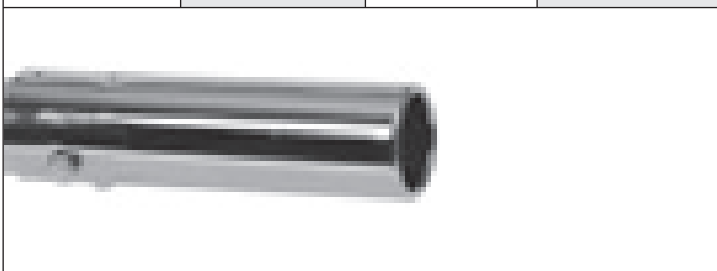

Bosal N°	d	L	T
267-128	Ø 28 - Ø 35	150 mm	Universal
267-136	Ø 36 - Ø 42	150 mm	Universal
267-143	Ø 43 - Ø 52	150 mm	Universal

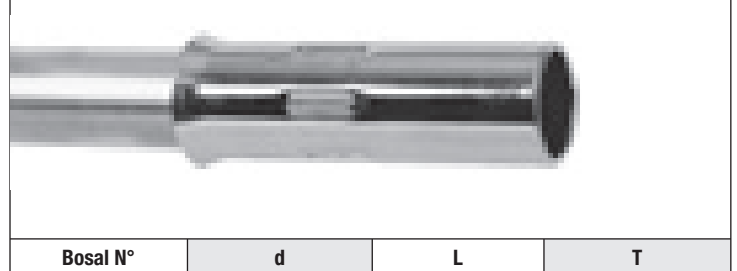

Bosal N°	d	L	T
267-335	Ø 35	120 mm	Universal
267-338	Ø 38	120 mm	Universal
267-339	Ø 41	90 mm	Universal
267-340	Ø 40	120 mm	Universal
267-341	Ø 41	120 mm	Universal
267-342	Ø 42	120 mm	Universal
267-344	Ø 44	90 mm	Universal
267-345	Ø 44	120 mm	Universal
267-346	Ø 45	90 mm	Universal
267-347	Ø 48	90 mm	Universal
267-348	Ø 48	120 mm	Universal
267-350	Ø 50	120 mm	Universal
267-352	Ø 52	120 mm	Universal
267-355	Ø 55	90 mm	Universal

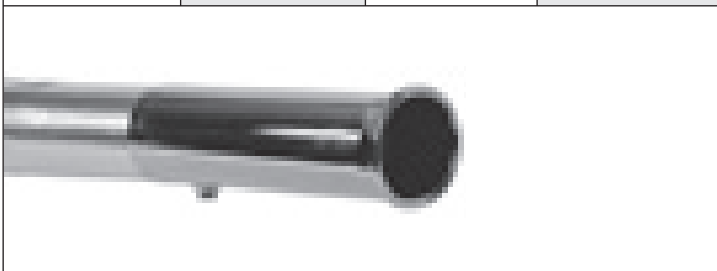

Bosal N°	d	L	T
267-020	47/55 oval	130 mm	Audi 80

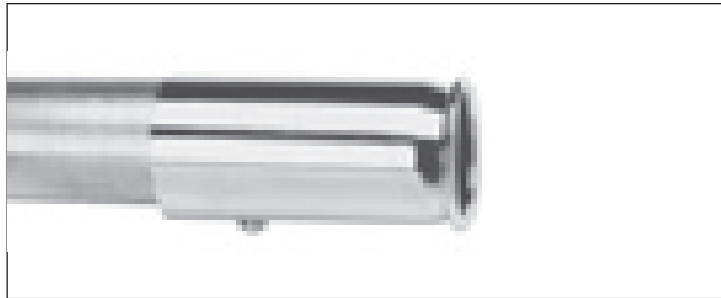

Bosal N°	d	L	T
267-205	Ø 42	60 mm	Volkswagen Golf/ Scirocco



Bosal N°	d	L	T
267-902	Ø 52	120 mm	Mercedes
267-979	Ø 45	120 mm	Mercedes

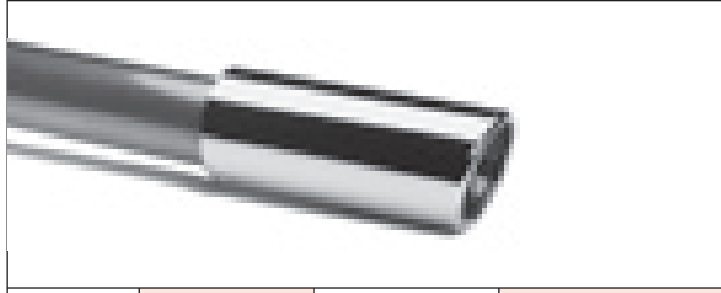

Bosal N°	d	L	D
267-405 (zwart/noir/ Schwartz/black)	Ø 41-50 mm	150 mm	72 mm

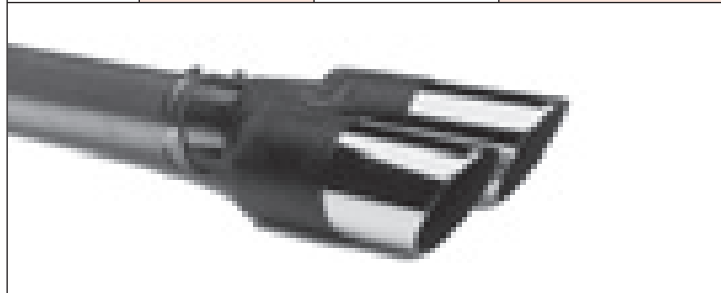

Bosal N°	d	L	D
267-401	Ø 30-50 mm	200 mm	2 x 57 mm

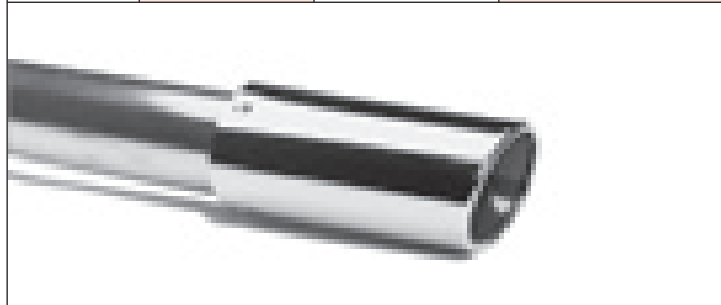

Bosal N°	d	L	D
267-406	Ø 38-55 mm	150 mm	82 x 67 mm

BROSPEED

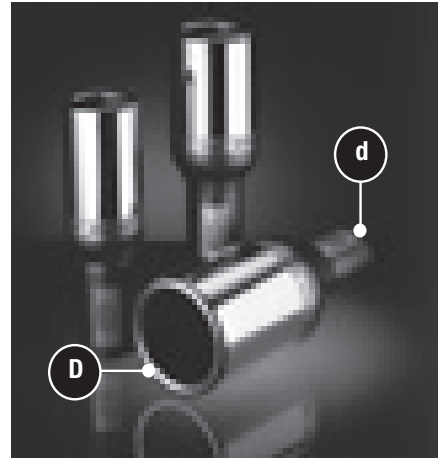

Bosal N°	d	L	D
267-046	Ø 53 mm	250 mm	Ø 90 mm

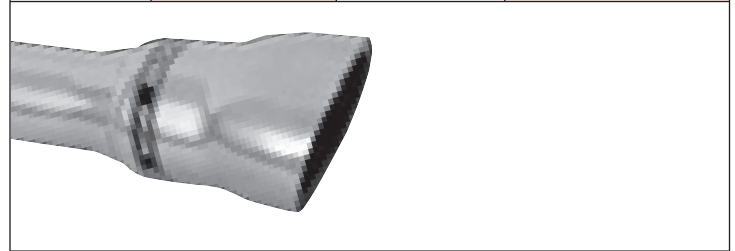

Bosal N°	d	L	D
267-931	Ø 63,15 mm	250 mm	120 x 80 mm

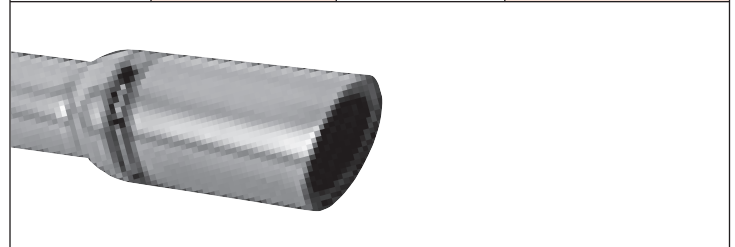

Bosal N°	d	L	D
267-933	Ø 57,15 mm	201 mm	Ø 76,20 mm

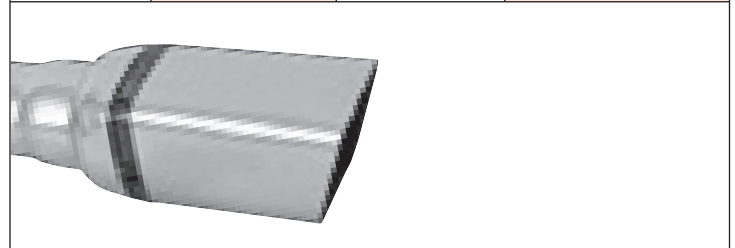

Bosal N°	d	L	D
267-302	Ø 50,80 mm	165,10 mm	50,8 x 50,8 mm

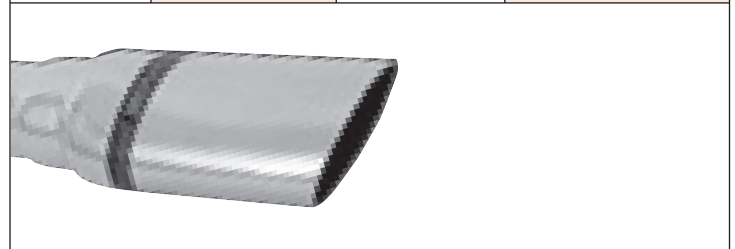

Bosal N°	d	L	D
267-310	Ø 57,15 mm	165,10 mm	69,85 mm